

# GAGES 2000

WIDELL products are available from

**MARYLAND METRICS**

EST. 1962

web: <http://mdmetric.com> email: [sales@mdmetric.com](mailto:sales@mdmetric.com)

ph: (410)358-3130 (800)638-1830 fx: (410)358-3142 (800)872-9329

P.O. Box 261 Owings Mills, MD 21117 USA

Widell Industries, Inc.

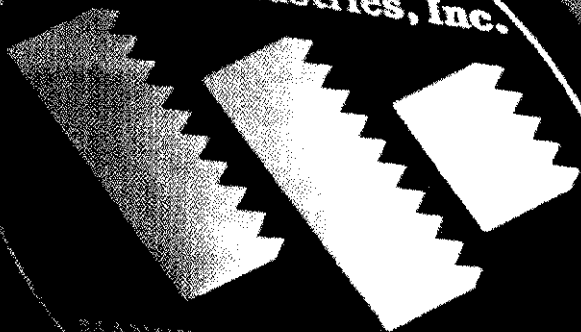

MANUFACTURERS OF SPECIAL  
TAPS, DIES AND GAGES

Due to the current volatile metals pricing, the prices in these catalogs  
are no longer valid. Please contact Maryland Metrics for current



# TABLE OF CONTENTS

**Due to the current volatile metals pricing, the prices in these catalogs are no longer valid. Please contact Maryland Metrics for current pricing.**

TAPERLOCK THREAD PLUGS UNC, UNF, UNEF .....	4
REVERSIBLE THREAD PLUGS UNC, UNF, UNEF .....	5
TRUNCATED SETTING PLUGS UNC, UNF, UNEF .....	6
THREAD RING GAGES UNC, UNF, UNEF .....	7
METRIC TAPERLOCK & REVERSIBLE THREAD PLUGS .....	8
METRIC THREAD SETTING PLUGS & RINGS .....	9
HOLE LOCATION THREAD PLUG UNC, UNF .....	10
HOLE LOCATION METRIC PLUGS .....	10
HELICAL COIL (STI) THREAD PLUGS .....	10
TAPER PIPE THREAD - PLUGS AND RINGS - NPT, NPTF .....	11
CARBIDE REVERSIBLE CYLINDRICAL PLUGS .....	12,13
REVERSIBLE CYLINDRICAL PLUGS .....	14
TAPERLOCK CYLINDRICAL PLUGS .....	15
TRILOCK CYLINDRICAL PLUGS .....	16
PROGRESSIVE CYLINDRICAL PLUGS .....	17
CYLINDRICAL RINGS .....	18
STANDARD GAGEMAKERS TOLERANCE CHART .....	18
MASTER SETTING DISCS .....	19

---

## ORDERING INSTRUCTIONS

1. QUANTITY DESIRED.
2. NOMINAL SIZE, THREADS PER INCH, AND CLASS OF FIT.
3. STYLE NUMBER OR COMPLETE DESCRIPTION: TAPERLOCK, REVERSIBLE, OR SET PLUGS, GO AND NOGO. DOUBLE END WITH HANDLE (D/E W/H), SINGLE END WITH HANDLE (S/E W/H) OR MEMBER ONLY (M/O).
4. ANY SPECIAL FEATURES SUCH AS: LEFT HAND, SPECIAL PITCH DIAMETER, SPECIAL THREAD, CHROME PLATING, ETC.

---

PRICES EFFECTIVE JULY 1, 2000  
MINIMUM ORDER \$25.00 NET

# SPECIAL GAGES

MANUFACTURED TO YOUR SPECIFICATIONS

QUOTED ON REQUEST

ACME  
MODIFIED ACME  
BLUE PRINT SPECIALS  
BRITISH  
BUTTRESS  
CYLINDRICAL

EXTRA LENGTH  
MULTIPLE LEADS  
SNAP GAGES  
SPECIAL THREAD FORMS  
SPLINE GAGES  
WHITWORTH

## CERTIFICATION SERVICES ON REQUEST

### NEW GAGES

#### THREADED PLUGS & RINGS

PITCH DIAMETER CERTIFICATION  
LONG FORM CERTIFICATION

\$8.00/NET EACH MEMBER  
\$10.00/NET EACH MEMBER

#### PIPE PLUGS & RINGS

PITCH DIAMETER CERTIFICATION  
LONG FORM CERTIFICATION

\$8.00/NET EACH MEMBER  
\$12.00/NET EACH MEMBER

#### CYLINDRICAL PLUGS & RINGS

CERTIFICATION OF ACTUAL SIZE  
(UP TO 5" DIA.)  
OVER 5" DIA. CONSULT FACTORY

\$12.00/NET EACH MEMBER

CERTIFICATES OF ACCURACY SUPPLIED AT NO CHARGE

### IN SERVICE GAGES

UP TO 1 1/2"

#### THREADED PLUGS

PITCH DIAMETER CERTIFICATION  
LONG FORM CERTIFICATION

\$10.00/NET PER MEMBER  
\$23.00/NET PER MEMBER

#### THREADED RINGS

PITCH DIAMETER CERTIFICATION  
LONG FORM CERTIFICATION

\$14.00/NET PER MEMBER  
\$26.00/NET PER MEMBER

Due to the current volatile metals pricing, the prices in these catalogs are no longer valid. Please contact Maryland Metrics for current pricing.

1 1/2" TO 4"

**THREADED PLUGS**

PITCH DIAMETER CERTIFICATION	\$13.00/NET PER MEMBER
LONG FORM CERTIFICATION	\$26.00/NET PER MEMBER

**THREADED RINGS**

PITCH DIAMETER CERTIFICATION	\$20.00/NET PER MEMBER
LONG FORM CERTIFICATION	\$33.00/NET PER MEMBER

OVER 4"

**THREADED PLUGS**

PITCH DIAMETER CERTIFICATION	\$16.00/NET PER MEMBER
LONG FORM CERTIFICATION	\$33.00/NET PER MEMBER

**THREADED RINGS**

PITCH DIAMETER CERTIFICATION	\$26.00/NET PER MEMBER
LONG FORM CERTIFICATION	\$46.00/NET PER MEMBER

UP TO 2"

**PIPE PLUGS**

PITCH DIAMETER CERTIFICATION	\$20.00/NET PER MEMBER
LONG FORM CERTIFICATION	\$26.00/NET PER MEMBER

**PIPE RINGS**

PITCH DIAMETER CERTIFICATION	\$20.00/NET PER MEMBER
LONG FORM CERTIFICATION	\$39.00/NET PER MEMBER

OVER 2"

**PIPE PLUGS**

PITCH DIAMETER CERTIFICATION	\$26.00/NET PER MEMBER
LONG FORM CERTIFICATION	\$33.00/NET PER MEMBER

**PIPE RINGS**

PITCH DIAMETER CERTIFICATION	\$26.00/NET PER MEMBER
LONG FORM CERTIFICATION	\$52.00/NET PER MEMBER

**SET PLUGS MUST BE FURNISHED OR PURCHASED ON SPECIAL SIZE RING GAGES**

**TERMINOLOGY**

**CERTIFICATE OF ACCURACY:** Statement indicates the gage complies with H28 & ANSI Standards.

**PITCH DIAMETER CERTIFICATION:** Indicates actual and specified pitch diameter of member.

**LONG FORM CERTIFICATION:** Includes measurements of pitch diameter, major diameter, minor diameter, flank angles, and lead.

Widell Industries, Inc. will not be held responsible, issue credit or replace any gage which the customer has surface treated, altered or abused in any manner. Discrepancies must be reported within 30 days, and returns will not be accepted without prior authorization by us.

*Due to the current volatile metals pricing, the prices in these catalogs are no longer valid. Please contact Maryland Metrics for current pricing.*

# TAPERLOCK THREAD PLUG GAGES



CLASS X TOLERANCE							
SIZE	THREADS PER INCH			GO OR NOGO	HANDLE	HANDLE	DOUBLE END
	UNC	UNF	UNEF	2B, 3B	SIZE	PRICE	GO/NOGO W/HANDLE
#0	----	80	----	31.00	000	8.60	70.60
#1	64	72	----	31.00	000	8.60	70.60
#2	56	64	----	31.00	000	8.60	70.60
#3	48	56	----	28.90	000	8.60	66.40
#4	40	48	----	28.90	00	8.60	66.40
#5	40	44	----	25.70	00	8.60	60.00
#6	32	40	----	25.70	00	8.60	60.00
#8	32	36	----	25.70	0	8.60	60.00
#10	24	32	----	25.70	0	8.60	60.00
#12	24	28	----	25.70	0	8.60	60.00
#12	----	----	32	43.90	0	8.60	96.40
1/4	20	28	----	22.50	1	7.50	52.50
1/4	----	----	32	42.80	1	7.50	93.10
5/16	18	24	----	22.50	1	7.50	52.50
5/16	----	----	32	42.80	1	7.50	93.10
3/8	16	24	----	23.50	2	7.50	54.50
3/8	----	----	32	49.20	2	7.50	105.90
7/16	14	20	----	23.50	2	7.50	54.50
7/16	----	----	28	49.20	2	7.50	105.90
1/2	13	20	----	24.60	2	7.50	56.70
1/2	----	----	28	49.20	2	7.50	105.90
9/16	12	18	----	31.00	3	7.50	69.50
9/16	----	----	24	53.50	3	7.50	114.50
5/8	11	18	----	31.00	3	7.50	69.50
5/8	----	----	24	53.50	3	7.50	114.50
11/16	----	----	24	54.60	3	7.50	116.70
3/4	10	16	----	35.30	3	7.50	78.10
3/4	----	----	20	54.60	3	7.50	116.70
13/16	----	----	20	56.70	3	7.50	120.90
7/8	8	14	----	38.50	4	8.60	85.60
7/8	----	----	20	58.90	4	8.60	126.40
15/16	----	----	20	59.90	4	8.60	128.40
1	8	12(14)	----	47.10	4	8.60	102.80
1	----	----	20	65.30	4	8.60	139.20
1 1/16	----	----	18	65.30	4	8.60	139.20
1 1/8	7	12	----	56.70	4	8.60	122.00
1 1/8	----	----	18	65.30	4	8.60	139.20
1 3/16	----	----	18	68.50	5	9.60	146.60
1 1/4	7	12	----	65.30	5	9.60	140.20
1 1/4	----	----	18	70.60	5	9.60	150.80
1 5/16	----	----	18	74.90	5	9.60	159.40
1 3/8	6	12	----	73.80	5	9.60	157.20
1 3/8	----	----	18	78.10	5	9.60	165.80
1 7/16	----	----	18	81.30	5	9.60	172.20
1 1/2	6	12	----	80.30	5	9.60	170.20
1 1/2	----	----	18	84.50	5	9.60	178.60

Due to the current volatile metals pricing, the prices in these catalogs are no longer valid. Please contact Mayland Metrics for current pricing.

**ALL TAPERLOCK THREAD WORK PLUGS ARE CHROME PLATED**

# REVERSIBLE THREAD PLUG GAGES



CLASS X TOLERANCE							
SIZE	THREADS PER INCH			GO OR NOGO 2B, 3B	HANDLE SIZE	HANDLE PRICE	DOUBLE END GO/NOGO W/HANDLE
	UNC	UNF	UNEF				
#0	----	80	----	40.70	1W	9.60	91.00
#1	64	72	----	40.70	1W	9.60	91.00
#2	56	64	----	40.70	2W	9.60	91.00
#3	48	56	----	37.50	2W	9.60	84.60
#4	40	48	----	37.50	2W	9.60	84.60
#5	40	44	----	34.20	2W	9.60	78.00
#6	32	40	----	34.20	2W	9.60	78.00
#8	32	36	----	34.20	2W	9.60	78.00
#10	24	32	----	34.20	2W	10.70	79.10
#12	24	28	----	34.20	3W	10.70	79.10
#12	----	----	32	59.90	3W	10.70	130.50
1/4	20	28	----	31.00	3W	10.70	72.70
1/4	----	----	32	55.60	3W	10.70	121.90
5/16	18	24	----	31.00	4W	10.70	72.70
5/16	----	----	32	55.60	4W	10.70	121.90
3/8	16	24	----	32.10	4W	10.70	74.90
3/8	----	----	32	59.90	4W	10.70	130.50
7/16	14	20	----	32.10	5W	11.80	76.00
7/16	----	----	28	59.90	5W	11.80	131.60
1/2	13	20	----	35.30	5W	11.80	82.40
1/2	----	----	28	65.30	5W	11.80	142.40
9/16	12	18	----	40.70	6W	12.80	94.20
9/16	----	----	24	71.70	6W	12.80	156.20
5/8	11	18	----	40.70	6W	12.80	94.20
5/8	----	----	24	71.70	6W	12.80	156.20
11/16	----	----	24	71.70	7W	12.80	156.20
3/4	10	16	----	44.90	7W	12.80	102.60
3/4	----	----	20	74.90	7W	12.80	162.50
13/16	----	----	20				
7/8	9	14	----				
7/8	----	----	20				
15/16	8	12(14)	----				
1	----	----	20				
1 1/16	----	----	18				
1 1/8	7	12	----				
1 1/8	----	----	18				
1 3/16	----	----	18				
1 1/4	7	12	----				
1 1/4	----	----	18				
1 5/16	----	----	18				
1 3/8	6	12	----				
1 3/8	----	----	18				
1 7/16	----	----	18				
1 1/2	6	12	----				
1 1/2	----	----	18				

Due to the current-volatile metals pricing, the prices in these catalogs are no longer valid. Please contact Maryland Metrics for current pricing.

**BABY TRILOCKS  
PRICED ON REQUEST**

**ALL REVERSIBLE THREAD WORK PLUGS ARE CHROME PLATED**

# TRUNCATED SETTING PLUG GAGES



CLASS X TOLERANCE							
SIZE	THREADS PER INCH			GO OR NOGO 2A, 3A	HANDLE SIZE	HANDLE PRICE	DOUBLE END GO/NOGO W/HANDLE
	UNC	UNF	UNEF				
#0	----	80	----	59.90	000	8.60	128.40
#1	64	72	----	59.90	000	8.60	128.40
#2	56	64	----	59.90	000	8.60	128.40
#3	48	56	----	55.60	000	8.60	119.80
#4	40	48	----	55.60	00	8.60	119.80
#5	40	44	----	52.40	00	8.60	113.40
#6	32	40	----	52.40	00	8.60	113.40
#8	32	36	----	52.40	0	8.60	113.40
#10	24	32	----	52.40	0	8.60	113.40
#12	24	28	----	54.60	0	8.60	117.80
#12	----	----	32	65.30	0	8.60	139.20
1/4	20	28	----	44.90	1	7.50	94.30
1/4	----	----	32	65.30	1	7.50	138.10
5/16	18	24	----	44.90	1	7.50	97.30
5/16	----	----	32	65.30	1	7.50	138.10
3/8	16	24	----	48.20	2	7.50	103.90
3/8	----	----	32	74.90	2	7.50	157.30
7/16	14	20	----	49.20	2	7.50	105.90
7/16	----	----	28	74.90	2	7.50	157.30
1/2	13	20	----	50.30	2	7.50	108.10
1/2	----	----	28	84.50	2	7.50	176.50
9/16	12	18	----	58.90	3	7.50	125.30
9/16	----	----	24	87.70	3	7.50	182.90
5/8	11	18	----	62.10	3	7.50	131.70
5/8	----	----	24	89.90	3	7.50	187.30
11/16	----	----	24	91.00	3	7.50	189.50
3/4	10	16	----	66.30	3	7.50	140.10
3/4	----	----	20	93.10	3	7.50	193.70
13/16	----	----	20	98.40	3	7.50	204.30
7/8	9	14	----	80.30	4	8.60	169.20
7/8	----	----	20	101.70	4	8.60	212.00
15/16	----	----	20	102.70	4	8.60	214.00
1	8	12(14)	----	93.10	4	8.60	194.80
1	----	----	20	110.20	4	8.60	229.00
1 1/16	----	----	18	109.10	4	8.60	226.80
1 1/8	7	12	----	109.10	4	8.60	226.80
1 1/8	----	----	18	115.60	4	8.60	239.80
1 3/16	----	----	18	119.80	5	9.60	249.20
1 1/4	7	12	----	119.80	5	9.60	249.20
1 1/4	----	----	18	133.80	5	9.60	277.20
1 5/16	----	----	18	135.90	5	9.60	281.40
1 3/8	6	12	----	138.00	5	9.60	285.60
1 3/8	----	----	18	141.20	5	9.60	292.00
1 7/16	----	----	18	144.50	5	9.60	298.60
1 1/2	6	12	----	145.50	5	9.60	300.60
1 1/2	----	----	18	150.90	5	9.60	311.40

Due to the current volatile metals pricing, the prices in these catalogs are no longer valid. Please contact Maryland Metrics for current pricing.

ALL SET PLUGS WILL  
BE SUPPLIED IN X TOLERANCE  
UNLESS OTHERWISE SPECIFIED.



# THREAD RING GAGES

## CLASS X TOLERANCE

SIZE	THREADS PER INCH			GO OR	GO AND NOGO	HOLDER	HOLDER
	UNC	UNF	UNEF	NOGO	WITHOUT HOLDER		
				2A, 3A	2A, 3A	NO.	PRICE
#0	----	80	----	116.60	233.20	1	12.80
#1	64	72	----	105.90	211.80	1	12.80
#2	56	64	----	87.70	175.40	1	12.80
#3	48	56	----	87.70	175.40	1	12.80
#4	40	48	----	79.20	158.40	1	12.80
#5	40	44	----	68.50	137.00	1	12.80
#6	32	40	----	69.60	139.20	1	12.80
#8	32	36	----	72.80	145.60	1	12.80
#10	24	32	----	72.80	145.60	1	12.80
#12	24	28	----	72.80	145.60	1	12.80
#12	----	----	32	95.20	190.40	1	12.80
1/4	20	28	----	64.20	128.40	2	15.00
1/4	----	----	32	85.60	171.20	2	15.00
5/16	18	24	----	64.20	128.40	2	15.00
5/16	----	----	32	85.60	171.20	2	15.00
3/8	16	24	----	68.50	137.00	3	17.10
3/8	----	----	32	88.80	177.60	3	17.10
7/16	14	20	----	68.50	137.00	3	17.10
7/16	----	----	28	88.80	177.60	3	17.10
1/2	13	20	----	74.90	149.80	3	17.10
1/2	----	----	28	96.30	192.60	3	17.10
9/16	12	18	----	85.60	171.20	4	20.30
9/16	----	----	24	102.70	205.40	4	20.30
5/8	11	18	----	85.60	171.20	4	20.30
5/8	----	----	24	103.80	207.60	4	20.30
11/16	----	----	24	104.90	209.80	4	20.30
3/4	10	16	----	111.30	222.60	4	20.30
3/4	----	----	20	125.20	250.40	4	20.30
13/16	----	----	20	127.30	254.60	4	20.30
7/8	9	14	----	124.10	248.20	5	26.80
7/8	----	----	20	133.80	267.60	5	26.80
15/16	----	----	20	138.00	276.00	5	26.80
1	8	12(14)	----	148.70	297.40	5	26.80
1	----	----	20	157.30	314.60	5	26.80
1 1/16	----	----	18	162.60	325.20	5	26.80
1 1/8	7	12	----	162.60	325.20	5	26.80
1 1/8	----	----	18	172.30	344.60	5	26.80
1 3/16	----	----	18	177.60	355.20	5	26.80
1 1/4	7	12	----	178.70	357.40	6	35.30
1 1/4	----	----	18	187.30	374.60	6	35.30
1 5/16	----	----	18	191.50	383.00	6	35.30
1 3/8	6	12	----	198.00	396.00	6	35.30
1 3/8	----	----	18	209.70	419.40	6	35.30
1 7/16	----	----	18	212.90	425.80	6	35.30
1 1/2	6	12	----	220.40	440.80	6	35.30
1 1/2	----	----	18	230.10	460.20	6	35.30

Due to the current volatile metals pricing, the prices in these catalogs are no longer valid. Please contact MyGrand Metrics for current pricing.

CHROME PLATE FOR RINGS ADD 15%



# METRIC TAPERLOCK & REVERSIBLE THREAD PLUG GAGES



6H TOLERANCE		TAPERLOCK				REVERSIBLE				
NOMINAL SIZE		PRICE EACH	HANDLE	DOUBLE END	PRICE EACH	HANDLE	DOUBLE END			
COURSE	FINE	MEMBER	SIZE	PRICE EACH	GO/NOGO W/HANDLE	MEMBER	SIZE	PRICE EACH	GO/NOGO W/HANDLE	
M1.6 x .35		39.60	000	8.60	87.80	48.20	1W	9.60	106.00	
M1.8 x .35		39.60	000	8.60	87.80	48.20	1W	9.60	106.00	
M2. x .40		39.60	000	8.60	87.80	48.20	2W	9.60	106.00	
M2.2 x .45		39.60	000	8.60	87.80	48.20	2W	9.60	106.00	
M2.5 x .45		36.40	000	8.60	81.40	48.20	2W	9.60	106.00	
M3. x .50		36.40	00	8.60	81.40	44.90	2W	9.60	99.40	
M3.5 x .60		32.10	00	8.60	72.80	38.50	2W	9.60	86.60	
M4. x .70		32.10	0	8.60	72.80	38.50	2W	9.60	86.60	
M4.5 x .75		33.20	0	8.60	75.00	39.60	2W	9.60	88.80	
M5. x .80		32.10	0	8.60	72.80	38.50	3W	10.70	87.70	
M6. x 1.0		26.80	1	7.50	61.10	32.10	3W	10.70	74.90	
M7. x 1.0		27.80	1	7.50	63.10	32.10	3W	10.70	74.90	
M8. x 1.25	1.00	25.70	1	7.50	58.90	32.10	4W	10.70	74.90	
M10. x 1.50	1.25	20.80	2	7.50	63.00	32.10	4W	10.70	74.90	
M12. x 1.75	1.25	30.00	2	7.50	67.50	36.40	5W	11.80	84.60	
M14. x 2.00	1.50	34.20	3	7.50	75.90	41.70	6W	12.80	96.20	
M16. x 2.00	1.50	34.20	3	7.50	75.90	41.70	6W	12.80	96.20	
M18. x 2.50	1.50	38.50	3	7.50	84.50	48.20	7W	12.80	109.20	
M20. x 2.50	1.50	42.80	3	7.50	93.10					
M22. x 2.50	1.50	42.80	4	8.60	94.20					
M24. x 3.00	2.00	49.20	4	8.60	107.00					
M27. x 3.00	2.00	66.30	4	8.60	141.20					
M30. x 3.50	2.00	79.20	5	9.60	168.00					
M33. x 3.50	2.00	79.20	5	9.60	168.00					
M36. x 4.00	3.00	91.00	5	9.60	191.60					
							<b>BABY TRILOCKS</b>			
							<b>PRICED ON</b>			
							<b>REQUEST</b>			
<b>TAPERLOCK AND REVERSIBLE THREAD WORK PLUGS CHROME PLATED</b>										

Due to the current volatile metals pricing, prices in these catalogs are no longer valid. Please contact Maryland Metals for current pricing.

# METRIC THREAD GAGES SETTING PLUGS & RINGS

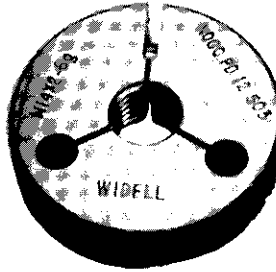

6g TOLERANCE		TRUNCATED SET PLUGS				THREAD RINGS			
NOMINAL SIZE		PRICE EACH	HANDLE PRICE	DOUBLE END GO/NOGO W/HANDLE	PRICE EACH MEMBER	GO AND NOGO W/OUT HOLDER	HOLDER PRICE		
COURSE	FINE	MEMBER	SIZE	EACH			SIZE	EACH	
M1.6 x .35		76.00	000	8.60	160.60	120.90	1	12.80	
M1.8 x .35		76.00	000	8.60	160.60	120.90	1	12.80	
M2. x .40		72.80	000	8.60	154.20	109.10	1	12.80	
M2.2 x .45		72.80	000	8.60	154.20	109.10	1	12.80	
M2.5 x .45		72.80	000	8.60	154.20	109.10	1	12.80	
M3. x .50		70.60	00	8.60	149.80	94.20	1	12.80	
M3.5 x .60		70.60	00	8.60	149.80	94.20	1	12.80	
M4. x .70		68.50	0	8.60	145.60	86.70	1	12.80	
M4.5 x .75		69.60	0	8.60	147.80	86.70	1	12.80	
M5. x .80		68.50	0	8.60	145.60	86.70	1	12.80	
M6. x 1.0		56.70	1	7.50	120.90	80.30	2	15.00	
M7. x 1.0		57.80	1	7.50	123.10	80.30	2	15.00	
M8. x 1.25	1.00	57.80	1	7.50	123.10	80.30	2	15.00	
M10. x 1.50	1.25	61.00	2	7.50	129.50	86.70	3	17.10	
M12. x 1.75	1.25	66.30	2	7.50	140.10	93.10	3	17.10	
M14. x 2.00	1.50	74.90	3	7.50	157.30	103.80	4	20.30	
M16. x 2.00	1.50	74.90	3	7.50	157.30	103.80	4	20.30	
M18. x 2.50	1.50	86.70	3	7.50	180.90	139.10	4	20.30	
M20. x 2.50	1.50	91.00	3	7.50	189.50	160.50	4	20.30	
M22. x 2.50	1.50	112.40	4	8.60	233.40	165.90	5	26.80	
M24. x 3.00	2.00	119.80	4	8.60	248.20	203.30	5	26.80	
M27. x 3.00	2.00	130.50	4	8.60	269.60	209.70	5	26.80	
M30. x 3.50	2.00	137.00	5	9.60	283.60	215.10	6	35.30	
M33. x 3.50	2.00	145.50	5	9.60	300.60	237.50	6	35.30	
M36. x 4.00	3.00	158.40	5	9.60	326.40	265.40	6	35.30	

CHROME PLATE FOR RINGS ADD 15%

Due to the current volatile metals pricing, the prices in these catalogs are no longer valid. Please contact Maryland Metric for current pricing.

# HOLE LOCATION GAGES

UNIFIED/ INCH MEASUREMENTS			
SIZE	THREADS PER INCH		PRICE
	UNC	UNF	
#0	----	80	80.30
#1	64	72	77.00
#2	56	64	74.90
#3	48	56	71.70
#4	40	48	67.40
#5	40	44	72.80
#6	32	40	73.80
#8	32	36	69.60
#10	24	32	68.50
#12	24	28	67.40
1/4	20	28	59.90
5/16	18	24	59.90
3/8	16	24	64.20
7/16	14	20	63.10
1/2	13	20	66.30
9/16	12	18	65.30
5/8	11	18	67.40
3/4	10	16	70.60
7/8	9	14	83.50
1	8	12	117.70

**ADD 15% FOR CHROME PLATING**

METRIC MEASUREMENTS	
SIZE	PRICE
M4 x 0.7	85.60
M5 x 0.8	81.30
M6 x 1.0	72.80
M8 x 1.25	72.80
M10 x 1.5	74.90
M12 x 1.75	78.10
M12 x 1.25	81.30

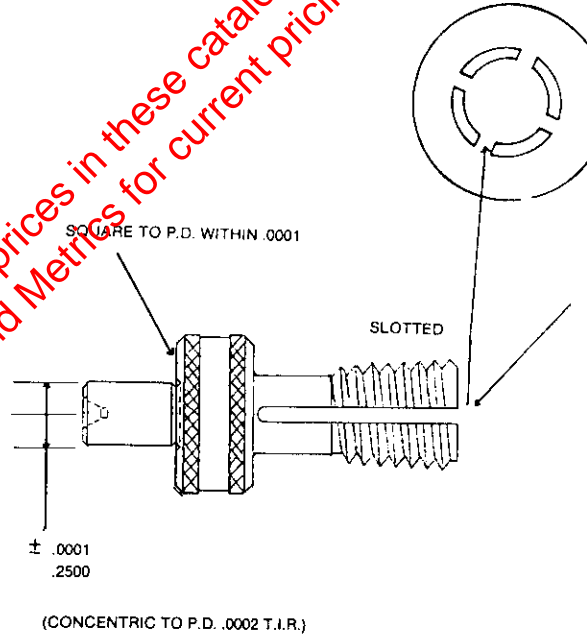

1. SIZES NOT SHOWN PRICED ON APPLICATION.
2. #10 AND SMALLER, M5 AND SMALLER ARE GROUND WITH FRONT TAPER TO COVER THE ENTIRE PRODUCT TOLERANCE AND ARE OF SOLID CONSTRUCTION.

## HELICAL COIL (STI) PLUGS

SIZE	THREADS PER INCH		GO OR NOGO	HANDLES	
	UNC	UNF		SIZE	PRICE
#2	56	----	41.70	00	8.60
#4	40	48	37.50	00	8.60
#5	40	----	37.50	0	8.60
#6	32	40	37.50	0	8.60
#8	32	36	37.50	0	8.60
#10	24	32	35.30	0	8.60
#12	24	----	35.30	1	7.50
1/4	20	28	34.20	1	7.50
5/16	18	24	34.20	2, 1	7.50
3/8	16	24	35.30	2	7.50
7/16	14	20	35.30	3, 2	7.50
1/2	13	20	38.50	3	7.50

**CHROMED**

Due to the current volatile metals pricing, the prices in these catalogs are no longer valid. Please contact Maryland Metrics for current pricing.

# TAPER PIPE PLUG AND RING GAGES



NPT				
SIZE	PLUG GAGE	RING GAGE	HANDLES	
			SIZE	PRICE EACH
1/16-27	58.90	110.20	1	7.50
1/8-27	40.70	77.00	2	7.50
1/4-18	47.10	84.50	3	7.50
3/8-18	53.50	97.40	3	7.50
1/2-14	59.90	108.10	4	8.60
3/4-14	68.50	123.10	4	8.60
1-11 1/2	77.00	140.20	5	9.60
1 1/4-11 1/2	84.50	153.00	5	9.60
1 1/2-11 1/2	96.30	181.90	5	9.60
2-11 1/2	116.60	218.30	5	9.60
2 1/2-8	140.20	255.70	6	12.80
3-8	164.80	317.80	6	12.80

L1 & L3 PLUGS SUPPLIED WITH 1 STEP. ADD \$15.00 FOR ADDITIONAL STEPS ON L1 & L3.

Due to the current volatile metal pricing, the prices in these catalogs are no longer valid. Please contact Maryland Metrics for current pricing.

NPTF							
SIZE	PLUGS		HANDLES		RINGS		
	L-1 L3	6-STEP PLAIN	SIZE	PRICE EACH	L-1	L-2	6-STEP PLAIN
1/16-27	59.20	117.70	1	7.00	115.60	162.60	193.70
1/8-27	55.60	117.70	2	7.00	80.30	156.20	193.70
1/4-18	66.30	117.70	3	7.00	96.30	162.60	193.70
3/8-18	79.20	117.70	3	7.00	101.70	171.20	193.70
1/2-14	89.90	117.70	4	8.00	113.40	177.60	193.70
3/4-14	99.50	124.10	4	8.00	129.50	195.80	217.20
1-11 1/2	109.10	134.80	5	9.00	146.60	212.90	217.20
1 1/4-11 1/2	123.10	151.90	5	9.00	159.40	233.30	219.40
1 1/2-11 1/2	140.20	166.90	5	9.00	190.50	255.70	251.50
2-11 1/2	166.90	233.30	5	9.00	227.90	298.50	306.00
2 1/2-8	221.50	352.00	6	12.00	267.50	358.50	367.00
3-8	267.50	384.10	6	12.00	333.80	421.60	440.80

LARGER SIZES AVAILABLE UPON REQUEST.  
 NPSL, NPSM, NPSF, ANPT AVAILABLE UPON REQUEST.

# CARBIDE REVERSIBLE CYLINDRICAL PLUG GAGES



GO OR NOGO MEMBERS					
SIZE RANGE		QTY 1	QTY 2	QTY 3-5	HANDLE
DECIMAL	METRIC				
<b>CLASS XX</b>					
.024-.040	.610-1.02	75.10	68.50	64.50	11.90
.041-.075	1.04-1.91	52.50	47.30	44.80	11.90
.076-1.00	1.93-2.54	49.40	44.40	41.90	11.90
.101-.131	2.57-3.33	52.70	44.80	41.50	11.90
.132-.181	3.35-4.60	52.50	45.40	42.30	11.90
.182-.231	4.62-5.87	56.30	49.10	46.00	11.90
.232-.282	5.89-7.16	60.30	53.00	49.30	11.90
.283-.345	7.19-8.76	65.20	56.80	53.00	13.20
.346-.407	8.79-10.34	70.50	62.40	58.30	13.20
.408-.461	10.36-11.71	76.70	73.80	69.10	13.20
.462-.511	11.73-12.98	81.30	76.40	73.10	13.20
.512-.561	13.00-14.25	98.30	90.50	86.60	15.80
.562-.611	14.27-15.52	111.80	102.90	98.40	15.80
.612-.661	15.54-16.79	124.70	114.80	109.80	15.80
.662-.710	16.81-18.03	135.30	125.70	120.40	17.10
.711-.761	18.06-19.33	146.20	137.60	131.60	17.10
.762-.824	19.35-20.93	160.50	152.70	146.20	22.40
.825-.871	20.96-22.12	172.50	163.80	157.10	22.40
.872-.918	22.15-23.32	186.40	176.90	169.40	22.40
.919-.971	23.34-24.66	198.10	188.20	180.20	22.40
.972-1.010	24.69-25.65	212.30	201.70	193.20	22.40
<b>CLASS X</b>					
.024-.040	.610-1.02	68.50	61.90	58.60	11.90
.041-.075	1.04-1.91	47.30	42.80	52.40	11.90
.076-1.00	1.93-2.54	44.40	40.10	37.90	11.90
.101-.131	2.57-3.33	47.40	40.50	37.20	11.90
.132-.181	3.35-4.60	47.30	41.00	38.20	11.90
.182-.231	4.62-5.87	50.60	44.30	41.50	11.90
.232-.282	5.89-7.16	54.30	47.70	44.80	11.90
.283-.345	7.19-8.76	58.40	51.20	48.00	13.20
.346-.407	8.79-10.34	63.40	56.50	52.80	13.20
.408-.461	10.36-11.71	69.10	66.30	62.20	13.20
.462-.511	11.73-12.98	73.40	68.80	66.00	13.20
.512-.561	13.00-14.25	88.60	81.50	78.00	15.80
.562-.611	14.27-15.52	100.60	92.60	88.60	15.80
.612-.661	15.54-16.79	112.30	103.30	98.80	15.80
.662-.710	16.81-18.03	121.70	113.10	108.30	17.10
.711-.761	18.06-19.33	131.60	123.70	118.50	17.10
.762-.824	19.35-20.93	144.70	137.50	131.70	22.40
.825-.871	20.96-22.12	155.30	147.50	141.30	22.40
.872-.918	22.15-23.32	167.60	159.40	152.50	22.40
.919-.971	23.34-24.66	178.20	169.20	162.30	22.40
.972-1.010	24.69-25.65	191.10	181.50	173.80	22.40

Due to the current volatile metals pricing, the prices in these catalogs are no longer valid. Please contact Maryland Metrics for current pricing.

# CARBIDE REVERSIBLE CYLINDRICAL PLUG GAGES



SIZE RANGE		GO OR NOGO MEMBERS				HANDLE
DECIMAL	METRIC	QTY 1	QTY 2	QTY 3-5		
<b>CLASS Y</b>						
.024-.040	.610-1.02	64.50	58.60	55.30	11.90	
.041-.075	1.04-1.91	45.10	40.50	38.20	11.90	
.076-.100	1.93-2.54	42.10	37.90	35.90	11.90	
.101-.131	2.57-3.33	45.10	38.40	35.20	11.90	
.132-.181	3.35-.460	45.00	38.90	36.40	11.90	
.182-.231	4.62-5.87	48.10	42.10	39.50	11.90	
.232-.282	5.89-7.16	51.50	45.40	42.70	11.90	
.283-.345	7.19-8.76	55.50	48.90	45.70	13.20	
.346-.407	8.79-10.34	60.30	53.80	50.40	13.20	
.408-.461	10.36-11.71	65.60	63.00	59.00	13.20	
.462-.511	11.73-12.98	69.50	65.00	62.60	13.20	
.512-.561	13.00-14.25	84.20	77.40	74.00	15.80	
.562-.611	14.27-15.52	95.50	88.00	84.20	15.80	
.612-.661	15.54-16.79	106.70	98.10	93.80	15.80	
.662-.710	16.81-18.03	116.20	107.50	102.90	17.10	
.711-.761	18.06-19.33	125.00	117.50	111.30	17.10	
.762-.824	19.35-20.93	137.50	130.60	125.00	22.40	
.825-.871	20.96-22.12	147.50	140.10	134.20	22.40	
.872-.918	22.15-23.32	159.40	151.30	144.90	22.40	
.919-.971	23.34-24.66	169.40	160.90	154.10	22.40	
.972-1.010	24.69-25.65	181.50	172.50	165.20	22.40	
<b>CLASS Z</b>						
.024-.040	.610-1.02	62.60	56.00	52.70	11.90	
.041-.075	1.04-1.91	43.10	38.90	36.90	11.90	
.076-.100	1.93-2.54	40.50	36.40	34.40	11.90	
.101-.131	2.57-3.33	43.30	36.90	33.90	11.90	
.132-.181	3.35-.460	43.10	37.50	34.90	11.90	
.182-.231	4.62-5.87	46.10	40.50	37.90	11.90	
.232-.282	5.89-7.16	49.50	43.70	41.00	11.90	
.283-.345	7.19-8.76	53.30	46.90	44.00	13.20	
.346-.407	8.79-10.34	57.80	51.70	48.50	13.20	
.408-.461	10.36-11.71	63.00	60.50	56.60	13.20	
.462-.511	11.73-12.98	66.70	63.00	60.10	13.20	
.512-.461	13.00-14.25	80.90	74.40	71.10	15.80	
.562-.611	14.27-15.52	91.90	84.40	80.70	15.80	
.612-.661	15.54-16.79	102.70	94.20	90.20	15.80	
.662-.710	16.81-18.03	111.00	103.40	98.80	17.10	
.711-.761	18.06-19.33	120.00	112.90	108.00	17.10	
.762-.824	19.35-20.93	132.00	125.40	120.10	22.40	
.825-.871	20.96-22.12	141.60	134.50	128.80	22.40	
.872-.918	22.15-23.32	152.90	145.30	139.30	22.40	
.919-.971	23.32-24.66	162.50	154.40	147.80	22.40	
.972-1.010	24.69-25.65	174.20	165.50	158.60	22.40	

Due to the current volatile metals pricing, the prices in these catalogs are no longer valid. Please contact Maryland Metrics for current pricing.

# REVERSIBLE CYLINDRICAL PLUG GAGES

## STEEL



### GO OR NOGO MEMBERS

SIZE RANGE		QTY 1-5	QTY 6	HANDLE	SIZE
DECIMAL	METRIC				
<b>CLASS XX</b>					
.030-.040	.760-1.016	24.60	24.60	11.60	1W
.040-.075	1.016-1.905	24.60	24.60	11.60	1W
.075-.180	1.905-4.572	24.60	24.60	11.60	2W
.180-.280	4.572-7.137	24.60	24.60	11.60	3W
.280-.406	7.137-10.312	24.60	24.60	13.00	4W
.406-.510	10.312-12.954	25.40	25.40	14.50	5W
.510-.635	12.954-16.129	26.10	26.10	15.90	6W
.635-.760	16.129-19.304	27.50	27.50	17.40	7W
.760-.880	19.304-22.352	43.40	43.40	23.20	8W
.880-1.000	22.352-25.654	43.40	43.40	23.20	8W
<b>CLASS X</b>					
.030-.040	.760-1.016	17.40	15.90	11.60	1W
.040-.075	1.016-1.905	17.40	15.90	11.60	1W
.075-.180	1.905-4.572	14.10	12.60	11.60	2W
.180-.280	4.572-7.137	14.10	12.60	11.60	3W
.280-.406	7.137-10.312	14.10	12.60	13.00	4W
.406-.510	10.312-12.954	18.80	17.00	14.50	5W
.510-.635	12.954-16.129	19.20	17.90	15.90	6W
.635-.760	16.129-19.304	20.30	18.40	17.40	7W
.760-.880	19.304-22.352	36.20	29.00	23.20	8W
.880-1.000	22.352-25.654	36.20	29.00	23.20	8W
<b>CLASS Y</b>					
.030-.040	.760-1.016	14.50	13.00	11.60	1W
.040-.075	1.016-1.905	14.50	13.00	11.60	1W
.075-.180	1.905-4.572	10.90	9.70	11.60	2W
.180-.280	4.572-7.137	10.90	9.70	11.60	3W
.280-.406	7.137-10.312	10.90	9.70	13.00	4W
.406-.510	10.312-12.954	11.60	10.10	14.50	5W
.510-.635	12.954-16.129	12.00	10.90	15.90	6W
.635-.760	16.129-19.304	15.50	14.10	17.40	7W
.760-.880	19.304-22.352	29.00	21.70	23.20	8W
.880-1.000	22.352-25.654	29.00	21.70	23.20	8W
<b>CLASS Z</b>					
.030-.040	.760-1.016	13.00	11.60	11.60	1W
.040-.075	1.016-1.905	13.00	11.60	11.60	1W
.075-.180	1.905-4.572	10.10	9.50	11.60	2W
.180-.280	4.572-7.137	10.10	9.50	11.60	3W
.280-.406	7.137-10.312	10.10	9.50	13.00	4W
.406-.510	10.312-12.954	10.90	9.50	14.50	5W
.510-.635	12.954-16.129	11.60	10.50	15.90	6W
.635-.760	16.129-19.304	14.90	13.00	17.40	7W
.760-.880	19.304-22.352	21.70	18.80	23.20	8W
.880-1.000	22.352-25.654	21.70	18.80	23.20	8W

Due to the current volatile metals pricing, the prices in these catalogs are no longer valid. Please contact Maryland Metrics for current pricing.



# TAPERLOCK CYLINDRICAL PLUG GAGES PLAIN STEEL



## AVAILABLE IN DOUBLE AND SINGLE END STYLES

SIZE RANGE		QTY 1		QTY 2		HANDLE
DECIMAL	METRIC	GO	NOGO	GO	NOGO	
<b>CLASS XX</b>						
<b>CONSULT FACTORY FOR PRICES</b>						
.105-.150	2.669-3.810					
.150-.185	3.810-4.699	41.30	35.80	35.80	31.80	13.00
.185-.240	4.699-6.096	41.30	35.80	35.80	31.80	13.00
.240-.365	6.096-9.271	44.20	38.70	37.20	33.30	13.00
.365-.510	9.271-12.954	47.80	41.30	38.70	34.70	13.00
.510-.825	12.954-20.955	48.60	44.20	41.30	35.80	13.00
.825-1.135	20.955-28.829	57.90	51.10	50.00	44.20	14.50
1.135-1.510	28.829-38.354	62.20	54.00	54.00	47.10	14.50
<b>CLASS X</b>						
<b>CONSULT FACTORY FOR PRICES</b>						
.105-.150	2.669-3.810					
.150-.185	3.810-4.699	33.30	30.40	25.00	25.00	13.00
.185-.240	4.699-6.096	33.30	30.40	27.50	25.00	13.00
.240-.365	6.096-9.271	34.70	31.80	30.40	26.50	13.00
.365-.510	9.271-12.954	37.20	33.30	33.30	27.50	13.00
.510-.825	12.954-20.955	38.70	34.70	34.70	30.40	13.00
.825-1.135	20.955-28.829	44.20	38.70	38.70	34.70	14.50
1.135-1.510	28.829-38.354	55.40	48.60	48.60	42.80	14.50
<b>CLASS Y</b>						
<b>CONSULT FACTORY FOR PRICES</b>						
.105-.150	2.669-3.810					
.150-.185	3.810-4.699	29.00	26.10	25.00	22.10	13.00
.185-.240	4.699-6.096	29.00	26.10	25.00	22.10	13.00
.240-.365	6.096-9.271	30.40	26.50	26.10	23.60	13.00
.365-.510	9.271-12.954	31.80	29.00	27.50	25.00	13.00
.510-.825	12.954-20.955	34.70	30.40	29.00	26.50	13.00
.825-1.135	20.955-28.829	35.80	31.80	33.30	30.40	14.50
1.135-1.510	28.829-38.354	42.80	37.20	38.70	33.30	14.50
<b>CLASS Z</b>						
<b>CONSULT FACTORY FOR PRICES</b>						
.105-.150	2.669-3.810					
.150-.185	3.810-4.699	22.10	19.60	18.20	16.70	13.00
.185-.240	4.699-6.096	22.10	19.60	18.20	16.70	13.00
.240-.365	6.096-9.271	23.60	21.10	19.60	18.20	13.00
.365-.510	9.271-12.954	25.00	22.10	21.10	19.60	13.00
.510-.825	12.954-20.955	26.50	23.60	22.10	21.10	13.00
.825-1.135	20.955-28.829	30.40	27.50	26.50	24.00	14.50
1.135-1.510	28.829-38.354	34.70	31.80	30.40	26.50	14.50

Due to the current volatile metals pricing, the prices in these catalogs are no longer valid. Please contact Maryland Metals for current pricing.

# TRILOCK CYLINDRICAL PLUG GAGES

## PLAIN STEEL

AVAILABLE IN DOUBLE AND SINGLE END STYLES

SIZE RANGE		QTY 1		QTY 2		
DECIMAL	METRIC	GO	NOGO	GO	NOGO	HANDLE
<b>CLASS XX</b>						
.760-.947	19.304-24.053	55.00	49.20	44.20	42.00	15.90
.947-1.135	24.053-28.829	56.50	52.10	49.20	43.40	15.90
1.135-1.510	28.829-38.354	62.20	56.50	53.60	47.80	15.90
1.510-1.760	38.354-44.074	91.20	81.10	79.60	70.90	17.40
1.760-2.010	44.074-51.054	91.20	81.10	79.60	70.90	17.40
2.010-2.260	51.054-57.404	112.90	102.80	97.00	88.30	20.30
2.260-2.510	57.404-63.754	112.90	102.80	97.00	88.30	20.30
2.510-2.760	63.754-70.104	131.70	114.40	112.90	101.30	20.30
2.760-3.010	70.104-76.454	131.70	114.40	112.90	101.30	20.30
3.010-3.260	76.454-82.806	159.20	133.20	137.50	120.20	20.30
3.260-3.510	82.806-89.154	159.20	133.20	137.50	120.20	20.30
3.510-3.760	89.154-95.504	186.70	153.40	159.20	139.00	20.30
3.760-4.010	95.504-101.854	186.70	153.40	159.20	139.00	20.30
<b>CLASS X</b>						
.760-.947	19.304-24.053	44.90	40.50	39.10	33.80	15.90
.947-1.135	24.053-28.829	47.80	42.00	40.50	34.70	15.90
1.135-1.510	28.829-38.354	53.60	46.30	44.90	39.10	15.90
1.510-1.760	38.354-44.074	73.80	60.80	62.20	55.00	17.40
1.760-2.010	44.074-51.054	73.80	60.80	62.20	55.00	17.40
2.010-2.260	51.054-57.404	91.20	81.10	78.20	68.00	20.30
2.260-2.510	57.404-63.754	91.20	81.10	78.20	68.00	20.30
2.510-2.760	63.754-70.104	110.00	88.30	92.60	84.00	20.30
2.760-3.010	70.104-76.454	110.00	88.30	92.60	84.00	20.30
3.010-3.260	76.454-82.806	115.80	105.70	110.00	98.40	20.30
3.260-3.510	82.806-89.154	115.80	105.70	110.00	98.40	20.30
3.510-3.760	89.154-95.504	152.00	121.60	130.30	115.80	20.30
3.760-4.010	95.504-101.854	152.00	121.60	130.30	115.80	20.30
<b>CLASS Y</b>						
.760-.947	19.304-24.053	36.20	31.80	30.40	27.50	15.90
.947-1.135	24.053-28.829	37.80	33.30	31.80	29.00	15.90
1.135-1.510	28.829-38.354	42.00	36.20	34.70	30.40	15.90
1.510-1.760	38.354-44.074	63.70	53.60	55.00	47.80	17.40
1.760-2.010	44.074-51.054	63.70	53.60	55.00	47.80	17.40
2.010-2.260	51.054-57.404	78.20	65.10	66.60	57.90	20.30
2.260-2.510	57.404-63.754	78.20	65.10	66.60	57.90	20.30
2.510-2.760	63.754-70.104	91.20	76.70	78.20	70.90	20.30
2.760-3.010	70.104-76.454	91.20	76.70	78.20	70.90	20.30
3.010-3.260	76.454-82.806	105.70	88.30	88.30	82.50	20.30
3.260-3.510	82.806-89.154	105.70	88.30	88.30	82.50	20.30
3.510-3.760	89.154-95.504	124.50	107.10	105.70	94.10	20.30
3.760-4.010	95.504-101.854	124.50	107.10	105.70	94.10	20.30
<b>CLASS Z</b>						
.760-.947	19.304-24.053	27.50	24.60	23.20	21.70	15.90
.947-1.135	24.053-28.829	30.40	27.50	26.10	23.20	15.90
1.135-1.510	28.829-38.354	31.80	29.00	29.00	24.60	15.90
1.510-1.760	38.354-44.074	49.20	43.40	42.00	36.20	17.40
1.760-2.010	44.074-51.054	49.20	43.40	42.00	36.20	17.40
2.010-2.260	51.054-57.404	62.20	53.60	55.00	46.30	20.30
2.260-2.510	57.404-63.754	62.20	53.60	55.00	46.30	20.30
2.510-2.760	63.754-70.104	72.40	62.20	60.80	55.00	20.30
2.760-3.010	70.104-76.454	72.40	62.20	60.80	55.00	20.30
3.010-3.260	76.454-82.806	86.90	72.40	76.70	62.20	20.30
3.260-3.510	82.806-89.154	86.90	72.40	76.70	62.20	20.30
3.510-3.760	89.154-95.504	102.80	88.30	86.90	73.80	20.30
3.760-4.010	95.504-101.854	102.80	88.30	86.90	73.80	20.30

Due to the current volatile metal pricing, the prices in these catalogs are no longer valid. Please contact Maryland Metrics for current pricing.



# PROGRESSIVE CYLINDRICAL GAGES

## STEEL

SIZE RANGE		QTY 1	QTY 2-4	QTY 5	HANDLE	HANDLE #
<b>CLASS XX</b>						
.105-.150	2.667-3.810	85.40	76.10	59.40	11.60	00
.150-.230	3.810-6.096	82.90	70.30	57.90	11.60	0
.230-.365	6.096-9.271	85.40	76.10	60.10	11.60	1
.365-.510	9.271-12.954	85.40	76.10	63.30	11.60	2
.510-.825	12.954-20.955	93.70	80.00	66.20	11.60	3
.825-1.135	20.955-28.829	100.70	89.80	74.60	11.60	4
1.135-1.510	28.829-38.754	120.20	102.10	85.40	13.00	5
1.510-1.760	38.754-44.704	172.30	149.10	122.70	15.90	5 1/2
1.760-2.010	44.704-51.054	172.30	149.10	122.70	15.90	5 1/2
2.010-2.260	51.054-57.404	216.50	187.50	155.70	15.90	6
2.260-2.510	57.404-63.754	216.50	187.50	155.70	15.90	6
<b>CLASS X</b>						
.105-.150	2.667-3.810	71.70	62.20	48.60	11.60	00
.150-.230	3.810-6.096	66.20	55.00	45.70	11.60	0
.230-.365	6.096-9.271	71.70	57.90	48.60	11.60	1
.365-.510	9.271-12.954	74.60	60.80	51.20	11.60	2
.510-.825	12.954-20.955	76.10	64.70	52.50	11.60	3
.825-1.135	20.955-28.829	85.40	73.20	60.80	11.60	4
1.135-1.510	28.829-38.754	97.80	80.00	68.80	13.00	5
1.510-1.760	38.754-44.704	136.50	118.70	97.80	15.90	5 1/2
1.760-2.010	44.704-51.054	136.50	118.70	97.80	15.90	5 1/2
2.010-2.260	51.054-57.404	172.30	149.10	122.70	15.90	6
2.260-2.510	57.404-63.754	172.30	149.10	122.70	15.90	6
<b>CLASS Y</b>						
.105-.150	2.667-3.810	56.50	48.60	40.10	11.60	00
.150-.230	3.810-6.096	55.00	45.70	38.70	11.60	0
.230-.365	6.096-9.271	55.00	48.60	40.10	11.60	1
.365-.510	9.271-12.954	57.90	49.60	42.80	11.60	2
.510-.825	12.954-20.955	63.30	54.00	44.20	11.60	3
.825-1.135	20.955-28.829	70.30	60.80	49.60	11.60	4
1.135-1.510	28.829-38.754	78.60	67.60	55.00	13.00	5
1.510-1.760	38.754-44.704	120.20	106.50	88.30	15.90	5 1/2
1.760-2.010	44.704-51.054	120.20	106.50	88.30	15.90	5 1/2
2.010-2.260	51.054-57.404	146.20	128.20	106.10	15.90	6
2.260-2.510	57.404-63.754	146.20	128.20	106.10	15.90	6
<b>CLASS Z</b>						
.105-.150	2.667-3.810	44.20	37.20	30.40	11.60	00
.150-.230	3.810-6.096	41.30	34.70	29.00	11.60	0
.230-.365	6.096-9.271	44.20	35.80	31.80	11.60	1
.365-.510	9.271-12.954	45.70	38.70	34.30	11.60	2
.510-.825	12.954-20.955	48.60	40.10	34.30	11.60	3
.825-1.135	20.955-28.829	55.00	45.70	38.70	11.60	4
1.135-1.510	28.829-38.754	60.80	52.50	44.20	13.00	5
1.510-1.760	38.754-44.704	92.30	82.90	68.80	15.90	5 1/2
1.760-2.010	44.704-51.054	92.30	82.90	68.80	15.90	5 1/2
2.010-2.260	51.054-57.404	118.70	102.10	88.30	15.90	6
2.260-2.510	57.404-63.754	118.70	102.10	88.30	15.90	6

ALSO AVAILABLE IN CARBIDE; CONSULT FACTORY FOR PRICING.

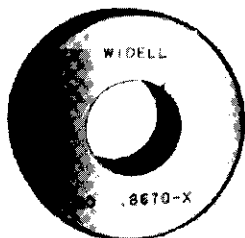

# CYLINDRICAL RING GAGES

SIZE RANGE		XX		X		Y		Z	
DECIMAL	METRIC	1	2	1	2	1	2	1	2
.070 - .150	1.780 - 3.810	114.80	100.90	103.20	90.50	99.80	87.00	96.30	84.70
.150 - .230	3.810 - 5.840	75.40	66.10	65.00	56.80	59.20	52.20	55.70	48.70
.230 - .365	5.840 - 9.271	77.70	68.40	69.60	61.50	66.10	58.00	62.60	54.50
.365 - .510	9.271 - 12.954	78.90	69.60	70.80	61.50	68.40	59.20	65.00	56.80
.510 - .825	12.954 - 20.955	84.70	74.20	75.40	66.10	70.80	61.50	67.30	59.20
.825 - 1.135	20.955 - 28.829	92.80	81.20	81.20	70.80	75.40	66.10	71.90	62.60
1.135 - 1.510	28.829 - 38.354	104.40	91.60	91.60	80.00	83.50	73.10	80.00	69.60
1.510 - 2.010	38.354 - 51.054	127.60	113.70	118.30	105.60	113.70	100.90	104.40	92.80
2.010 - 2.510	51.054 - 63.754	163.60	145.00	141.50	126.40	128.80	114.80	123.00	109.00
2.510 - 3.010	63.754 - 76.454	189.10	168.20	167.00	148.50	147.30	131.10	141.50	126.40
3.010 - 3.510	76.454 - 89.154	220.40	196.00	191.40	170.50	169.40	150.80	161.20	143.80
3.510 - 4.010	89.154 - 101.854	251.70	223.90	213.10	193.70	199.50	177.50	192.60	171.70
4.010 - 4.760	101.854 - 120.904	281.90	250.60	250.60	222.70	225.00	200.70	218.10	158.90
4.760 - 5.510	120.904 - 139.956	353.80	314.40	310.90	277.20	281.90	250.60	257.50	229.70
5.510 - 6.260	139.956 - 159.004	410.60	365.40	366.60	326.00	345.70	307.40	328.30	292.30
6.260 - 7.010	159.004 - 178.054	494.20	439.60	461.70	410.60	423.40	377.00	406.00	361.90
7.010 - 7.760	178.054 - 197.104	517.40	460.50	486.00	432.70	443.10	394.40	423.40	377.00
7.760 - 8.510	197.104 - 216.154	596.20	530.10	546.40	486.00	501.10	445.40	476.80	424.60

PRICING AVAILABLE ON SIZES LARGER THAN SHOWN

CHROME PLATE ADD 30%

ALSO AVAILABLE IN CARBIDE; CONSULT FACTORY FOR PRICING

## STANDARD GAGEMAKER'S TOLERANCE CHART

SIZE RANGE		TOLERANCES				
ABOVE	TO AND INCLUDING	CLASS XXX	CLASS XX	CLASS X	CLASS Y	CLASS Z
.005	.010	.00001	.00002	.00004	.00007	.00010
.010	.029	.00001	.00002	.00004	.00007	.00010
.029	.825	.00001	.00002	.00004	.00007	.00010
.825	1.510	.000015	.00003	.00006	.00009	.00012
1.510	2.510	.00002	.00004	.00008	.00012	.00016
2.510	4.510	.000025	.00005	.00010	.00015	.00020
4.510	6.510	.000033	.000065	.00013	.00019	.00025
6.510	9.010	.00004	.00008	.00016	.00024	.00032
9.010	12.260	.00005	.00010	.00020	.00030	.00040

# MASTER SETTING DISCS

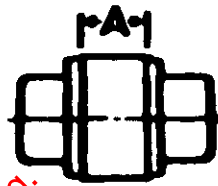
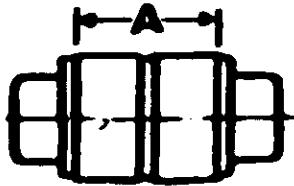
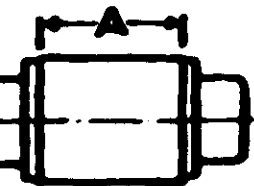

Due to the current volatile metals pricing the prices in these catalogs are no longer valid. please contact Marland Metals for current pricing.

SIZE RANGE		STYLE #1			STYLE #2			STYLE #3		
DECIMAL	METRIC	XX	X	Y	XX	X	Y	XX	X	Y
.150-230	3.810-6.096	73.10	54.50	49.90	124.10	92.80	82.40	67.30	49.90	46.40
.230-365	6.098-9.271	75.40	55.70	51.00	125.30	94.00	83.50	68.40	51.00	47.60
.365-510	9.273-12.954	76.60	56.80	52.20	126.40	96.30	88.20	70.80	52.20	48.70
.510-825	12.956-20.955	77.70	58.00	54.40	127.60	97.40	89.30	71.90	53.40	49.90
.825-1.135	20.957-28.829	82.40	62.60	61.50	142.70	106.70	104.40	77.70	58.00	54.50
1.135-1.510	28.831-38.354	90.50	67.30	62.60	156.60	118.30	104.40	83.50	61.50	55.70
1.510-1.760	38.356-44.704	104.40	77.70	67.30	177.50	132.20	119.50	95.10	71.90	62.60
1.760-2.010	44.706-51.054	104.40	77.70	67.30	177.50	132.20	119.50	95.10	71.90	62.60
2.010-2.260	51.056-57.404	119.50	88.20	80.00	208.80	154.30	133.40	112.50	84.70	71.90
2.260-2.510	57.406-63.754	119.50	88.20	80.00	208.80	154.30	133.40	112.50	84.70	71.90
2.510-2.760	63.756-70.104	139.20	107.90	90.50	240.10	178.60	153.10	126.40	94.00	81.20
2.760-3.010	70.106-76.454	139.20	107.90	90.50	240.10	178.60	153.10	126.40	94.00	81.20
3.010-3.260	76.456-82.884	155.40	118.30	104.40	283.00	212.30	184.40	147.30	111.40	92.80
3.260-3.510	82.806-89.154	155.40	118.30	104.40	283.00	212.30	220.40	147.30	111.40	92.80
3.510-3.760	89.156-95.504	182.10	135.70	118.30	303.90	240.10	205.30	155.40	126.40	107.90
3.760-4.010	95.506-101.854	182.10	135.70	118.30	303.90	240.10	205.30	155.40	126.40	107.90
<b>4.010 AND LARGER CONSULT FACTORY FOR PRICING</b>										
<b>ALSO AVAILABLE IN CARBIDE; CONSULT FACTORY FOR PRICING</b>										

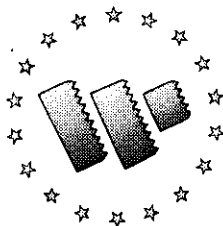

**Due to the current volatile metals pricing, the prices in these catalogs are no longer valid. Please contact Maryland Metrics for current pricing.**

Dear Valued Customers:

On behalf of myself and all the employees at **Widell Industries, Inc.** we would like to thank all of our distributors for helping us achieve over 35 years of manufacturing special threading tools.

**Widell**, the pioneer of same day service for special taps and dies, up to 8 inch in diameter, is still setting the standard for the cutting tool industry.

Although our reputation was built on service, our growth is made possible by increasing demand for our quality products.

It is our commitment to fast service and quality products that has made us one of the leading manufacturers of special threading tools.

With three plants, strategically located throughout the U.S.A., and a highly trained professional staff to answer any of your application needs, we offer the finest in customer service and satisfaction. **Widell** is committed to continuous same day quotes on blue print specials.

Through your continued support, **Widell** will always be the leading supplier of Special Acme threading tools in the U.S.A. and we have the world's largest range of special threading dies in stock.

Again, all of us at **Widell Industries** say thank you for your support over the past 35 years and we look forward to continuing to provide you with the quality and service you deserve.

Sincerely,

*Wayne Widell*

Wayne Widell  
*President*